

Analog Telephony / Modem Couplers

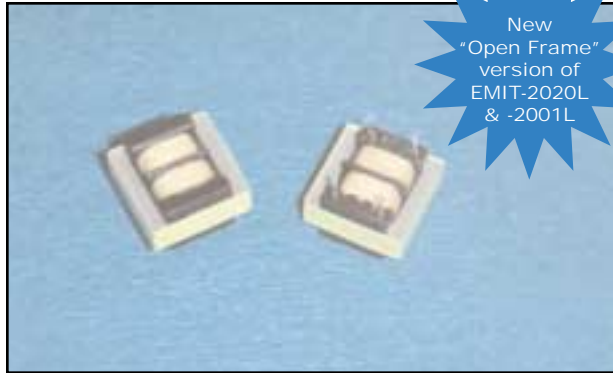

DESCRIPTION

The REMtech Magnetics MIT-4211 is a "Dry" Modem Isolation Transformer suitable for up to V.90 (56 kbps) consumer and internet analog modem applications compliant with Worldwide safety norms.

MIT-4211 offers IEC60950 Supplementary safety for lower cost compared to EMIT-2020L or EMIT-2001L. Other performance characteristics of the EMIT-2020L (the higher-rated EMIT) are the same with MIT-4211.

FEATURES

- Suitable for modem speeds up to V.90 (56 kbps).
- Total Harmonic Distortion rated -93 dB typ. @ 600 Hz, -10 dBm and -70 dB typ. @ 150 Hz, -3 dBm.
- Insertion Loss rated 1.20 dB typ. @ 2000 Hz.
- Complies with IEC60950 Supplementary safety norms.
- Matches 600 Ohm and complex impedance telephone lines.
- Uses minimal external components for impedance matching.
- Very small PCB footprint (16.5 mm x 16.5 mm).
- Very-Low-Profile (10.5 mm).
- Industry-standard pin configuration.

PRODUCT COMPLIANCE

- UL / C-UL recognized file number: E171120
- BSI certificate number(s): 8047, 8048
- BAPT certificate of recognition: 1905

NOMENCLATURE (Fig. 1)

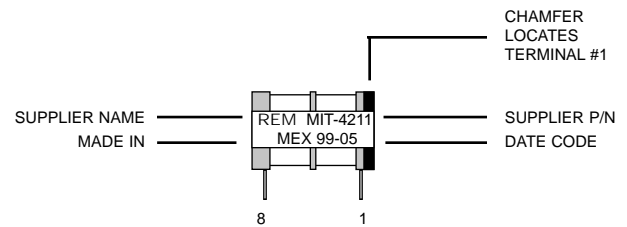

MECHANICAL DIMENSIONS (Fig. 2)

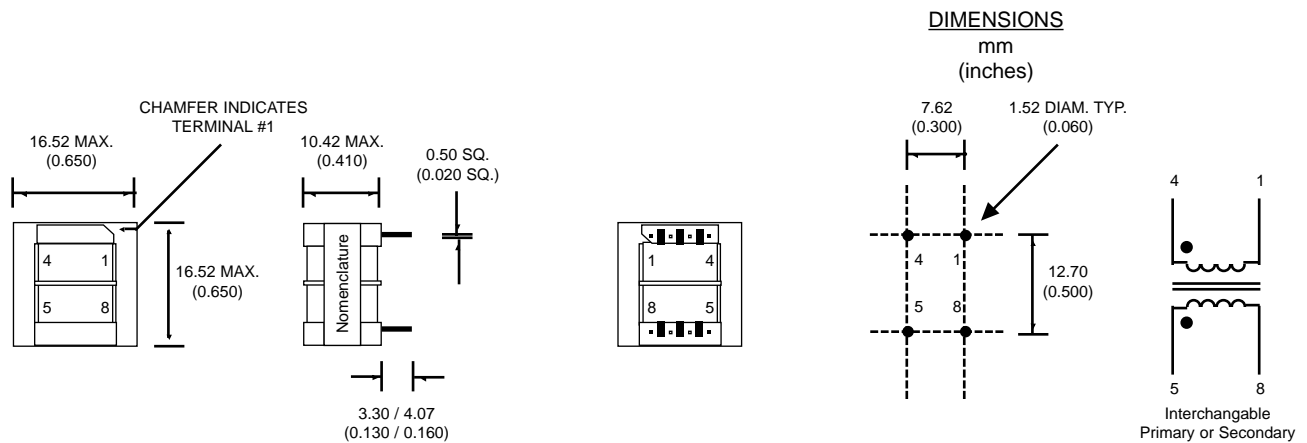

Literature Number: DSA.MIT-4211
© Copyright 2000, REMtech Corporation
All rights reserved. Printed in U.S.A.
9/00

Analog Telephony / Modem Couplers

ELECTRICAL PERFORMANCE SPECIFICATIONS

Electrical Performance Specifications ($T_A = 25\text{ }^\circ\text{C}$ unless otherwise specified)

PARAMETERS	CONDITIONS	MIN	TYP	MAX	UNITS
Impedance	Reflected on Primary With Load on Secondary	-	600	-	Ohms
		-	560	-	Ohms
Total Harmonic Distortion	@ 600 Hz, -10 dBm @ 150 Hz, -3 dBm	-	-93	-85	dB
		-	-70	-60	dB
Insertion Loss	Per IEEE method; @ 2000 Hz	-	1.20	1.50	dB
Return Loss	200 Hz - 4000 Hz Per 600 Ohm Match (Fig. 3) Per CTR21 Pan-Euro Match (Fig. 10)	18	-	-	dB
		22	-	-	dB
Dielectric Breakdown Isolation Production methods applied:	Safety Standard tested 1 Min.	1500	-	-	Vrms
	HiPot Voltage	1875	-	-	Vrms
	Duration	2	-	-	Sec
	Trip Leakage Current	-	-	200	μA
Frequency Response	200 Hz - 4000 Hz	-	± 0.50	-	dB
Longitudinal Balance	Per FCC part 68.310 60 Hz - 1000 Hz 1000 Hz - 4000 Hz	60	-	-	dB
		40	-	-	dB
DC Resistance @ 20°C , $\pm 10\%$	Primary Winding Secondary Winding	-	67	-	Ohms
		-	67	-	Ohms
DC Current in Primary	-	-	0	-	mADC
Turns Ratio	Primary to Secondary; $\pm 2\%$	-	1:1	-	Turns
Operating Temperature	-	-40	-	105	$^\circ\text{C}$
Storage Temperature	-	-40	-	125	$^\circ\text{C}$
Soldering Temperature	10 Sec. Max.	-	-	260	$^\circ\text{C}$

600 OHM MATCH (Fig. 3)

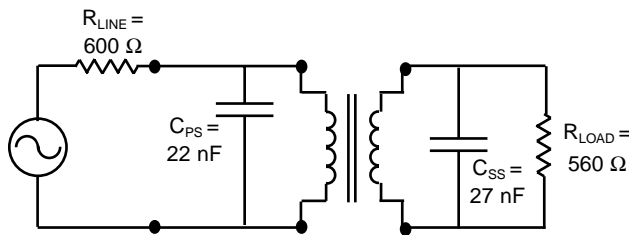

SCHEMATIC EQUIVALENT (Fig. 4)

(Typical Transformer Model @ 1 V, 1 kHz)

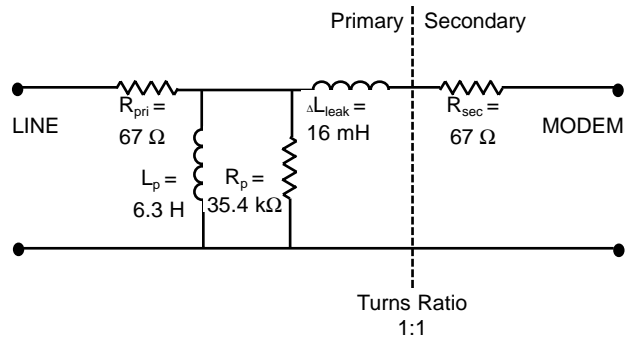

REMtech Corporation makes no assertion or warranty that the circuitry and the uses thereof disclosed herein are non-infringing on any valid US or foreign patents. REMtech assumes no liability as a result of the use of said specifications and reserves the right to make changes to specifications without notice. REMtech does not authorize or warrant any REMtech device for use in life support devices and/or systems. Contact your nearest REMtech Sales Office for the latest specifications.

Literature Number: DSB.MIT-4211
© Copyright 2000, REMtech Corporation
All rights reserved. Printed in U.S.A.
9/00

STANDARD PACKAGING (Fig. 9)

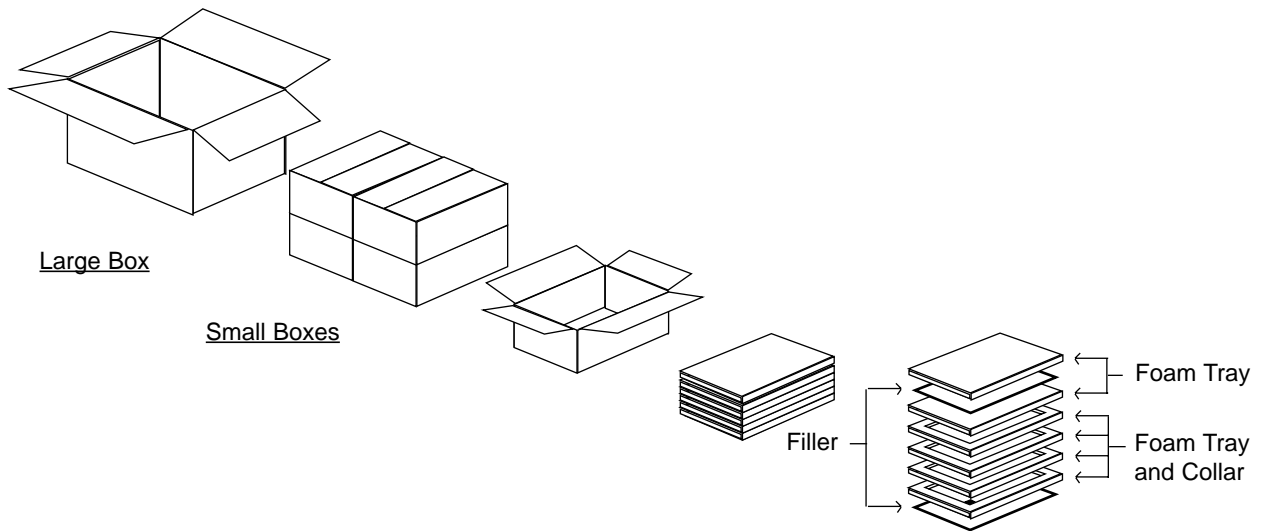

Packaging

Material	Contents	#Transformers
Large Box	4 Small Boxes	2640
Small Box	4 Trays	660
Tray	165 Transformers	165
---	Transformer	1

PAN-EUROPEAN CTR21 MATCH (Fig. 10)

(Application circuits available on request for specific national match requirements.)

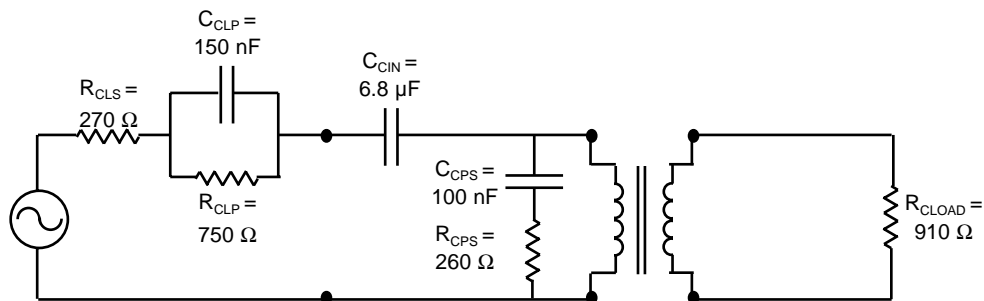

Literature Number: DSC.MIT-4211
 © Copyright 2000, REMtech Corporation
 All rights reserved. Printed in U.S.A.
 9/00

Analog Telephony / Modem Couplers

PERFORMANCE DATA

TOTAL HARMONIC DISTORTION (Fig. 5)

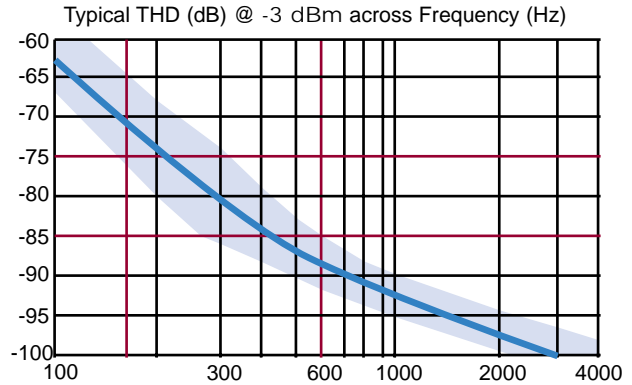
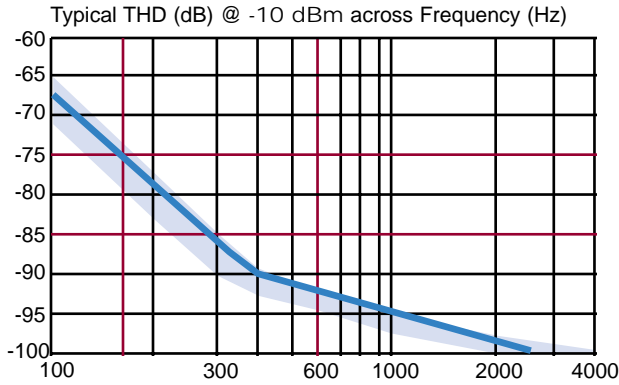

INSERTION LOSS (Fig. 6)

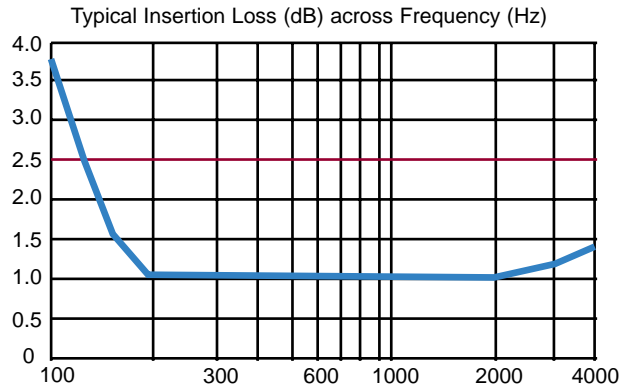

FREQUENCY RESPONSE (Fig. 7)

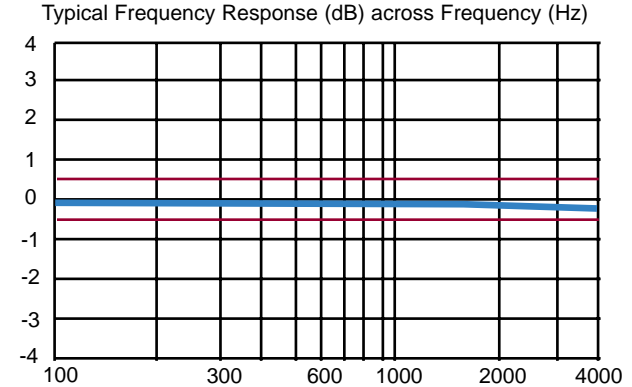

RETURN LOSS (Fig. 8)

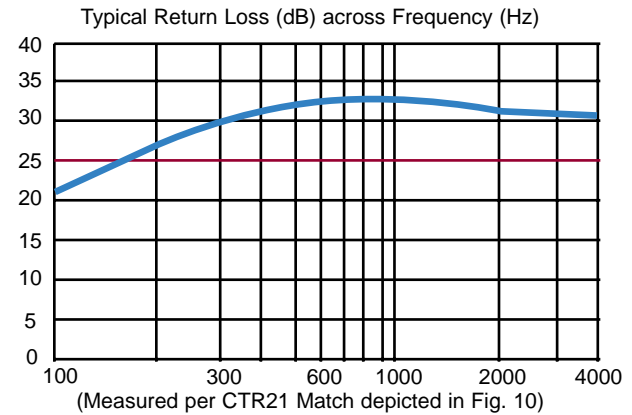
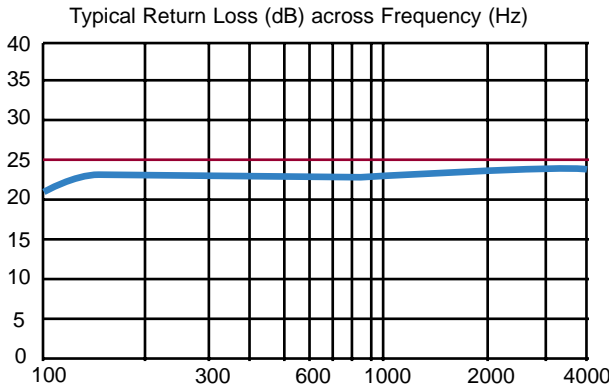

REMtech Corporation makes no assertion or warranty that the circuitry and the uses thereof disclosed herein are non-infringing on any valid US or foreign patents. REMtech assumes no liability as a result of the use of said specifications and reserves the right to make changes to specifications without notice. REMtech does not authorize or warrant any REMtech device for use in life support devices and/or systems. Contact your nearest REMtech Sales Office for the latest specifications.

Literature Number: DSD.MIT-4211
© Copyright 2000, REMtech Corporation
All rights reserved. Printed in U.S.A.
9/00