

OUTLINE

The RP103 Series are CMOS-based voltage regulator ICs with high output voltage accuracy, extremely low supply current, low ON-resistance, and high ripple rejection. Each of these ICs consists of a voltage reference unit, an error amplifier, resistor-net for voltage setting, a current limit circuit, and a chip enable circuit.

These ICs perform with low dropout voltage and a chip enable function. The line transient response and load transient response of the RP103 Series are excellent, thus these ICs are very suitable for the power supply for hand-held communication equipment.

The output voltage of these ICs is fixed with high accuracy. Since the packages for these ICs are PLP1010-4 therefore high density mounting of the ICs on boards is possible.

FEATURES

- Low Supply Current..... TYP. 36 μ A
- Standby Mode TYP. 0.1 μ A
- Low Dropout Voltage TYP. 0.220V (I_{OUT} =150mA, 2.5V Output type)
- High Ripple Rejection TYP. 75dB (f =1kHz 2.5V Output type)
- Low Temperature-Drift Coefficient of Output Voltage TYP. \pm 30ppm/ $^{\circ}$ C
- Excellent Line Regulation..... TYP. 0.02%/V
- High Output Voltage Accuracy..... \pm 1.0%
- Small Packages PLP1010-4, SOT-23-5, SC-82AB
- Output Voltage..... 1.2V, 1.3V, 1.5V, 1.8V, 1.85V, 1.9V, 2.0V, 2.5V,
2.6V, 2.7V, 2.8V, 2.85V, 2.9V, 3.0V, 3.1V, 3.3V
- Built-in Fold Back Protection Circuit..... TYP. 40mA (Current at short mode)
- Ceramic capacitors are recommended to be used with this IC..... C_{IN} = C_{OUT} =0.47 μ F or more

APPLICATIONS

- Power source for portable communication equipment.
- Power source for electrical appliances such as cameras, VCRs and camcorders.
- Power source for battery-powered equipment.

BLOCK DIAGRAMS

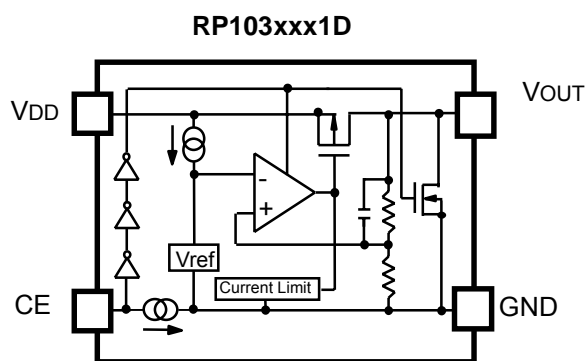
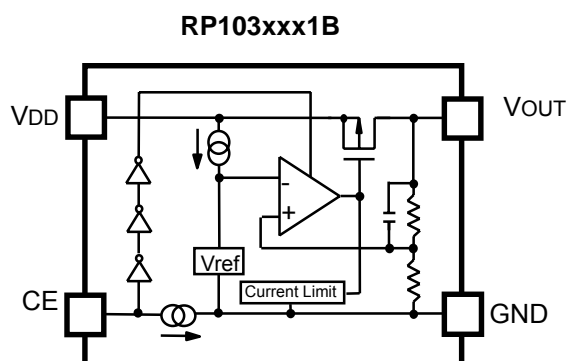

SELECTION GUIDE

The output voltage, version, and the taping type for the ICs can be selected at the user's request. The selection can be made with designating the part number as shown below;

RP103xxx1x-xx ←Part Number
 ↑ ↑ ↑ ↑
 a b c d

Code	Contents
a	Designation of Package Type: K: PLP1010-4 N: SOT-23-5 Q: SC-82AB
b	Setting Output Voltage (V_{OUT}): 1.2V, 1.3V, 1.5V, 1.8V, 1.85V, 1.9V, 2.0V, 2.5V, 2.6V, 2.7V, 2.8V, 2.85V, 2.9V, 3.0V, 3.3V Exception: 1.85V=RP103x181x5, 2.85V=RP103x281x5
c	Designation of Active Type: B: active high type* D: active high, with auto discharge*
d	Designation of Taping Type: Ex. TR (refer to Taping Specifications; TR type is the standard direction.)

*When the mode is into standby with CE signal, auto-discharge transistor turns on, and it makes the turn-off speed faster than normal type.

PIN CONFIGURATION

● **PLP1010-4**

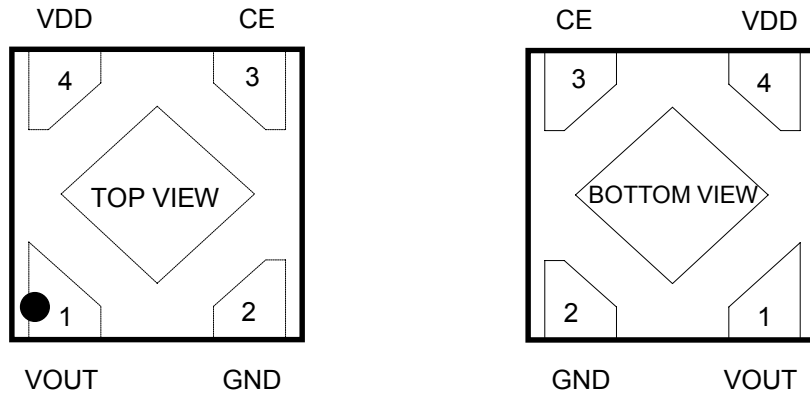

● **SOT-23-5**

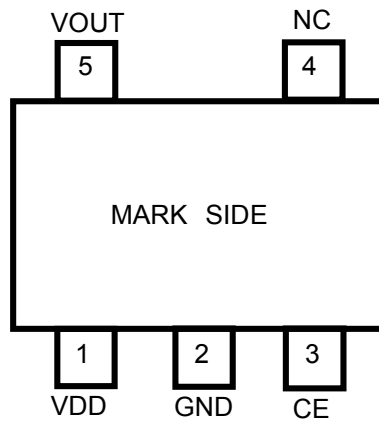

● **SC-82AB**

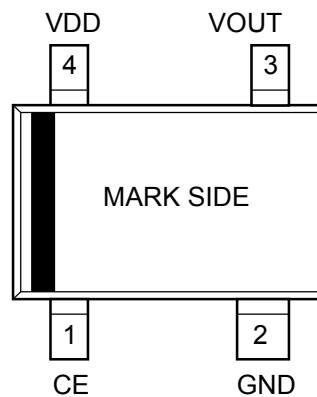

PIN DESCRIPTIONS

• RP103K

Pin No.	Symbol	Description
1	V _{OUT}	Output Pin
2	GND	Ground Pin
3	CE	Chip Enable Pin ("H" Active)
4	V _{DD}	Input Pin

Tab is GND level. (They are connected to the reverse side of this IC.)

Do not connect to other wires or land patterns.

• RP103N

Pin No.	Symbol	Description
1	V _{DD}	Input Pin
2	GND	Ground Pin
3	CE	Chip Enable Pin ("H" Active)
4	NC	No Connection
5	V _{OUT}	Output Pin

• RP103Q

Pin No.	Symbol	Description
1	CE	Chip Enable Pin ("H" Active)
2	GND	Ground Pin
3	V _{OUT}	Output Pin
4	V _{DD}	Input Pin

ABSOLUTE MAXIMUM RATINGS

Symbol	Item	Rating	Unit	
V_{IN}	Input Voltage	6.0	V	
V_{CE}	Input Voltage (CE Pin)	6.0	V	
V_{OUT}	Output Voltage	$-0.3 \sim V_{IN} + 0.3$	V	
I_{OUT}	Output Current	200	mA	
P_D	Power Dissipation	PLP1010-4 ^{*1}	mW	
		SOT-23-5 (Free Air) ^{*2}		250
		SC-82AB ^{*2}		380
T_{opt}	Operating Temperature Range	$-40 \sim 85$	$^{\circ}C$	
T_{stg}	Storage Temperature Range	$-55 \sim 125$	$^{\circ}C$	

*1: This value is under evaluation.

*2: For Power Dissipation, please refer to PACKAGE INFORMATION (from p.8) to be described

ELECTRICAL CHARACTERISTICS

- RP103xxx

- V_{IN} = Set $V_{OUT} + 1V$ for V_{OUT} options greater than 1.5V. $V_{IN} = 2.5V$ for $V_{OUT} \leq 1.5V$. $I_{OUT} = 1mA$, $C_{IN} = C_{OUT} = 0.47\mu F$, unless otherwise noted.

$T_{opt} = 25^{\circ}C$

Symbol	Item	Conditions	MIN.	TYP.	MAX.	Unit
V_{OUT}	Output Voltage	(*1)	$V_{OUT} \times 0.99$ (-20mV)		$V_{OUT} \times 1.01$ (20mV)	V
I_{OUT}	Output Current		150			mA
$\Delta V_{OUT}/\Delta I_{OUT}$	Load Regulation	$1mA \leq I_{OUT} \leq 150mA$		10	40	mV
V_{DIF}	Dropout Voltage	Please see the data sheet below				
I_{SS}	Supply Current	$I_{OUT} = 0mA$		36	48	μA
$I_{standby}$	Supply Current (Standby)	$V_{CE} = 0V$		0.1	1.0	μA
$\Delta V_{OUT}/\Delta V_{IN}$	Line Regulation	Set $V_{OUT} + 0.5V \leq V_{IN} \leq 5.0V$		0.02	0.10	%/V
RR	Ripple Rejection	$f = 1kHz$, Ripple 0.2Vp-p $V_{IN} = \text{Set } V_{OUT} + 1V$, $I_{OUT} = 30mA$ (In case that $V_{OUT} \leq 2.0V$, $V_{IN} = 3V$)		75		dB
V_{IN}	Input Voltage	(*2)	1.7		5.0	V
$\Delta V_{OUT}/\Delta T$	Output Voltage Temperature Coefficient	$-40^{\circ}C \leq T_{opt} \leq 85^{\circ}C$		± 30		ppm/ $^{\circ}C$
I_{LIM}	Short Current Limit	$V_{OUT} = 0V$		40		mA
I_{PD}	CE Pull-down Current			0.3		μA
V_{CEH}	CE Input Voltage "H"		1.5			V
V_{CEL}	CE Input Voltage "L"				0.3	V
en	Output Noise	$BW = 10Hz \text{ to } 100kHz$ $I_{OUT} = 30mA$		60		μV_{rms}

(*1) $V_{out} \leq 2.0V$, $\pm 20mV$ accuracy

(*2) Max. Input Voltage is 5.5V during 500 hours

Dropout Voltage

V_{OUT} (V)	Dropout Voltage (V)		
	Condition	TYP.	MAX.
$1.2V \leq V_{OUT} < 1.5V$	$I_{OUT} = 150mA$	0.500	0.620
$1.5V \leq V_{OUT} < 1.7V$		0.380	0.470
$1.7V \leq V_{OUT} < 2.0V$		0.340	0.420
$2.0V \leq V_{OUT} < 2.5V$		0.280	0.360
$2.5V \leq V_{OUT} < 2.8V$		0.220	0.290
$2.8V \leq V_{OUT} \leq 3.3V$		0.210	0.260

Confidential

RICOH

TECHNICAL NOTES

When using these ICs, consider the following points:

Phase Compensation

In these ICs, phase compensation is made for securing stable operation even if the load current is varied. For this purpose, use a capacitor C_{OUT} with good frequency characteristics and ESR (Equivalent Series Resistance). (Note: If additional ceramic capacitors are connected with parallel to the output pin with an output capacitor for phase compensation, the operation might be unstable. Because of this, test these ICs with as same external components as ones to be used on the PCB.)

PCB Layout

Make V_{DD} and GND lines sufficient. If their impedance is high, noise pickup or unstable operation may result. Connect a capacitor with a capacitance value as much as $0.47\mu\text{F}$ or more between V_{DD} and GND pin, and as close as possible to the pins.

Set external components, especially the output capacitor, as close as possible to the ICs, and make wiring as short as possible.

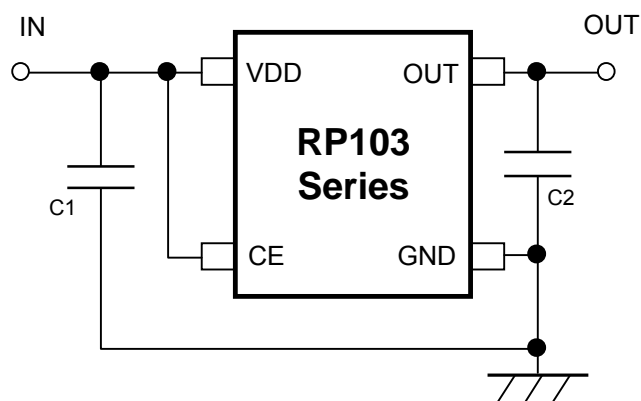

(External Components)

Output Capacitor $0.47\mu\text{F}$ MURATA: GRM155B30J474KE18B

POWER DISSIPATION (SOT-23-5)

This specification is at mounted on board. Power Dissipation (PD) depends on conditions of mounting on board. This specification is based on the measurement at the condition below:

(Power Dissipation (SOT-23-5) is substitution of SOT-23-6.)

Measurement Conditions

	Standard Test Land Pattern
Environment	Mounting on Board (Wind velocity=0m/s)
Board Material	Glass cloth epoxy plastic (Double sided)
Board Dimensions	40mm*40mm*1.6mm
Copper Ratio	Top side: Approx. 50%, Back side: Approx. 50%
Through-holes	φ 0.5mm * 44pcs

Measurement Result

(T_{opt}=25°C, T_{jmax}=125°C)

	Standard Test Land Pattern	Free Air
Power Dissipation	420mW	250mW
Thermal Resistance	$\theta_{ja} = (125-25^{\circ}\text{C})/0.42\text{W} = 263^{\circ}\text{C/W}$	400°C/W

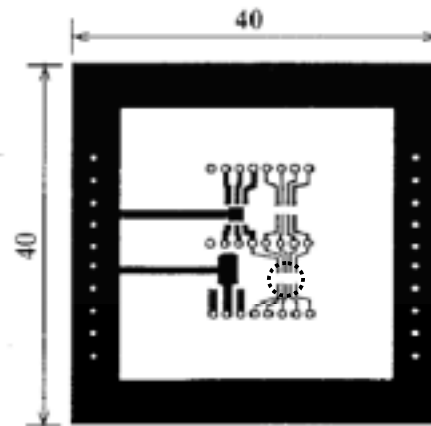
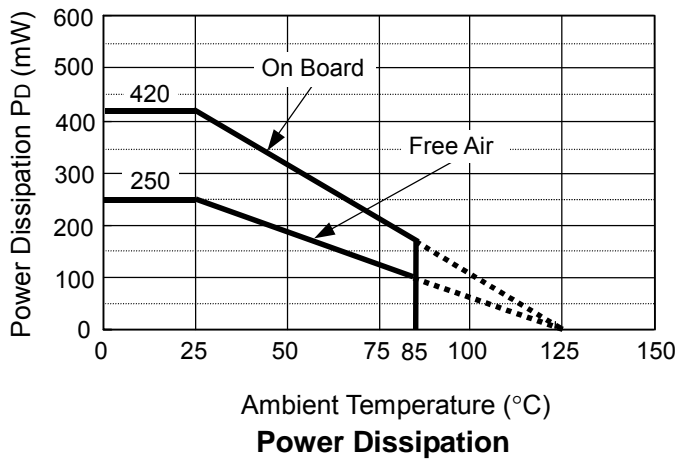

Measurement Board Pattern

○ IC Mount Area (Unit: mm)

POWER DISSIPATION (SC-82AB)

This specification is at mounted on board. Power Dissipation (PD) depends on conditions of mounting on board. This specification is based on the measurement at the condition below:

Measurement Conditions

	Standard Land Pattern
Environment	Mounting on Board (Wind velocity=0m/s)
Board Material	Glass cloth epoxy plactic (Double sided)
Board Dimensions	40mm × 40mm × 1.6mm
Copper Ratio	Top side : Approx. 50% , Back side : Approx. 50%
Through-hole	φ0.5mm × 44pcs

Measurement Result

(T_{opt}=25°C, T_{jmax}=125°C)

	Standard Land Pattern	Free Air
Power Dissipation	380mW	150mW
Thermal Resistance	$\theta_{ja}=(125-25^{\circ}\text{C})/0.38\text{W}=263^{\circ}\text{C/W}$	667°C/W

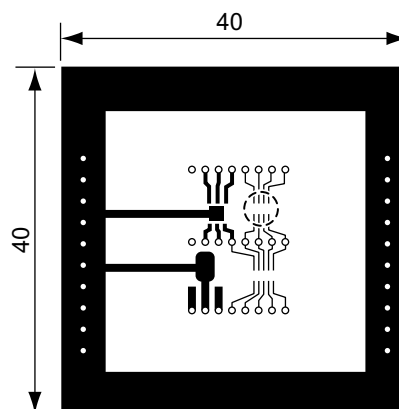
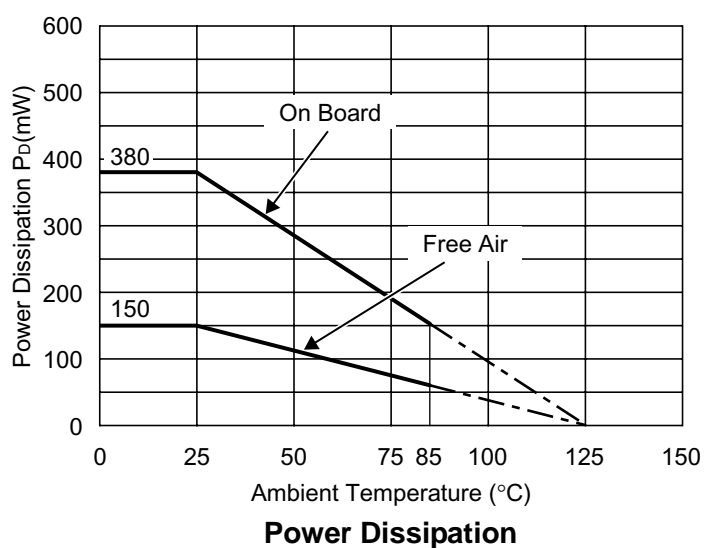

Measurement Board Pattern

○ IC Mount Area (Unit : mm)

TYPICAL CHARACTERISTICS

1) Output Voltage vs. Output Current $C_{in}=0.47\mu F$, $C_{out}=0.47\mu F$

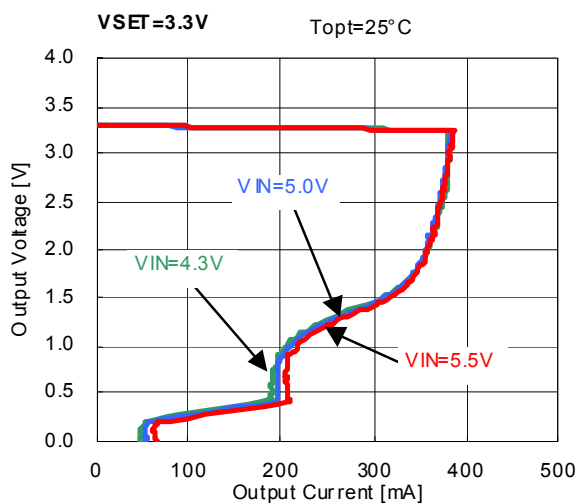
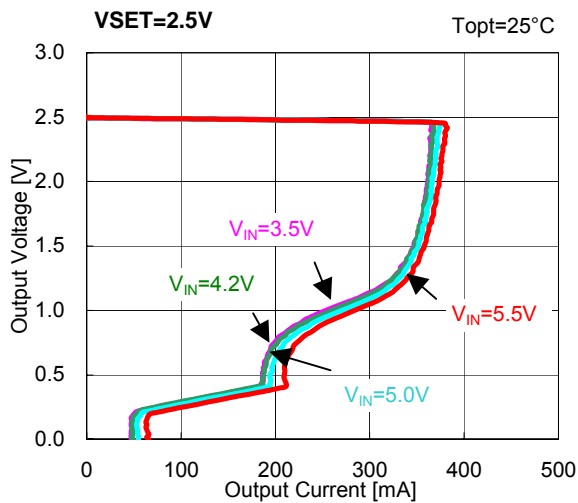
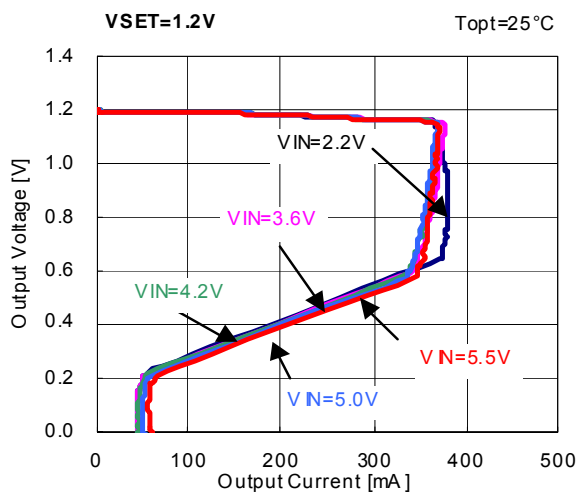

2) Output Voltage vs. Input Voltage $C_{in}=0.47\mu F$, $C_{out}=0.47\mu F$

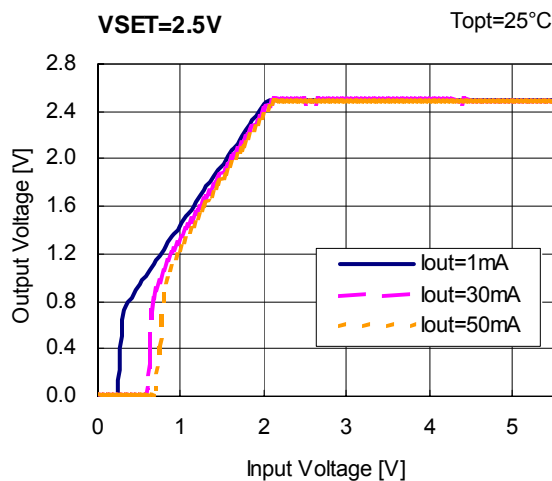
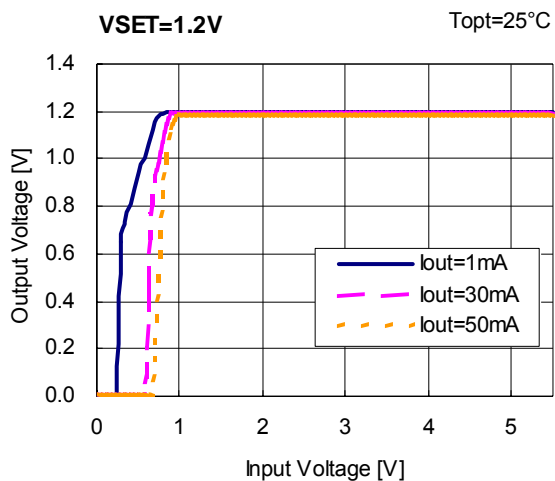

Confidential

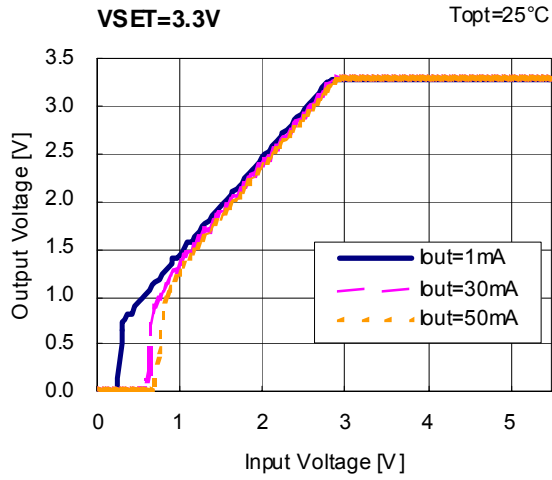

3) Supply Current vs. Input Voltage

Cin=0.47uF , Cout=0.47uF

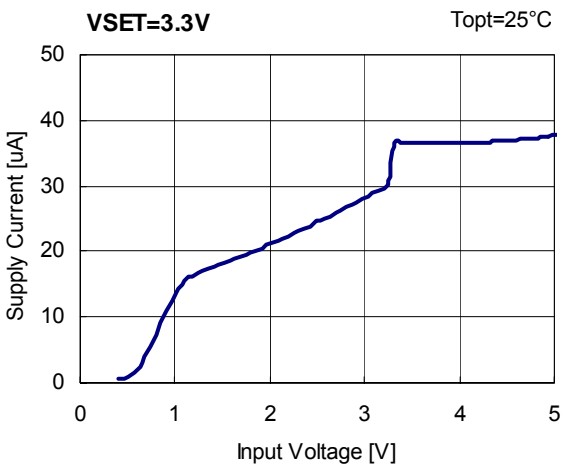
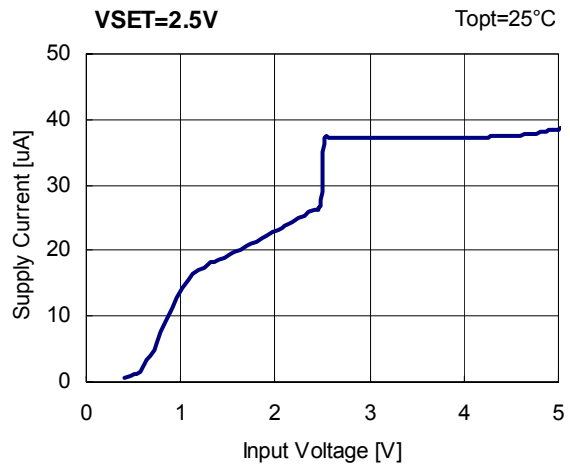
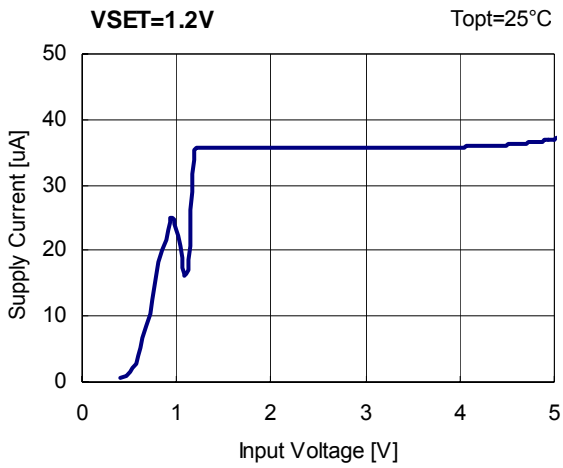

4) Output Voltage vs. Temperature $C_{in}=0.47\mu F$, $C_{out}=0.47\mu F$

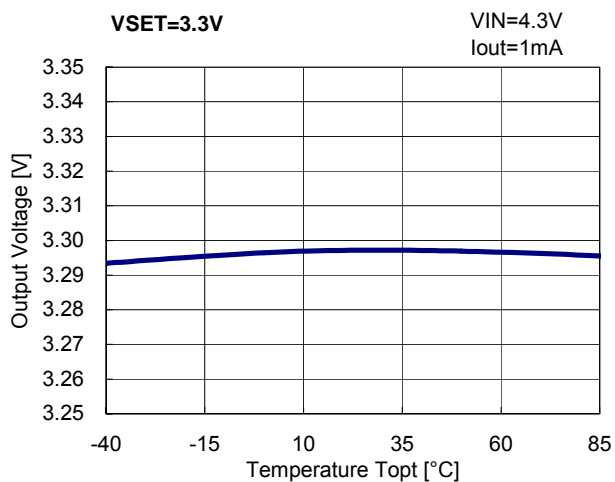
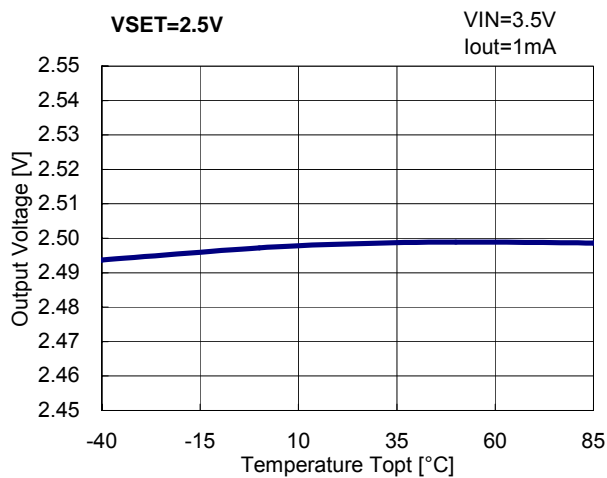
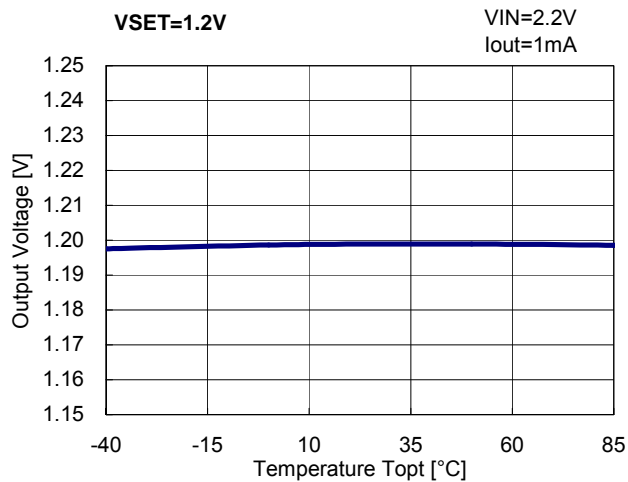

5) Supply Current vs. Temperature $C_{in}=0.47\mu F$, $C_{out}=0.47\mu F$

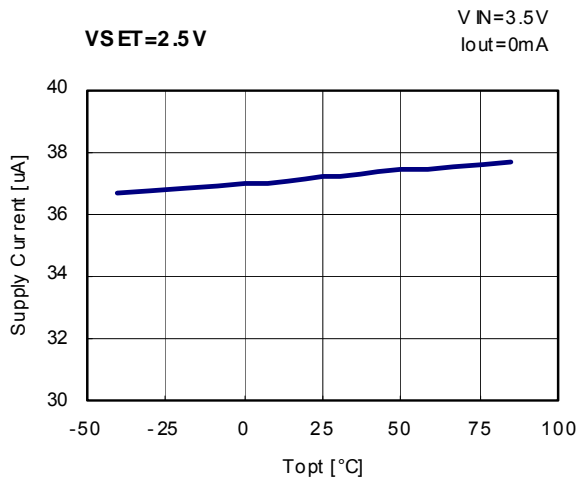
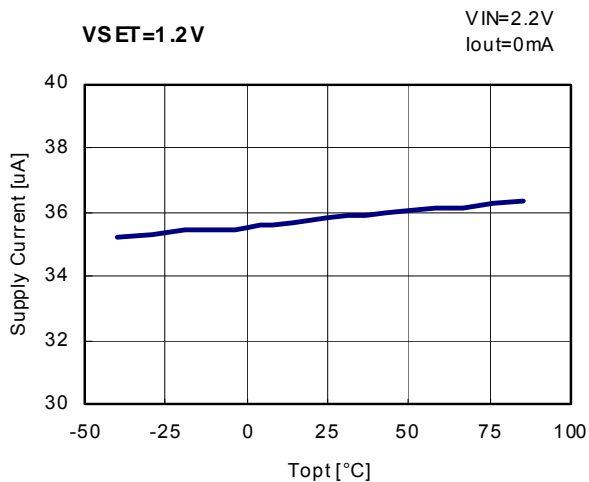

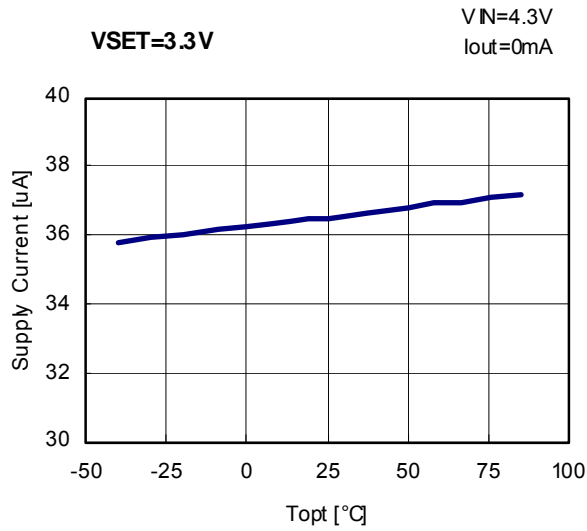

6) Dropout Voltage vs. Output Current

C_{in}=0.47µF, C_{out}=0.47µF

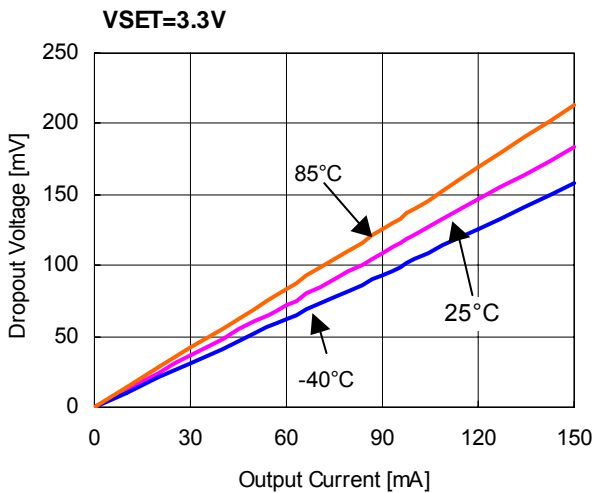
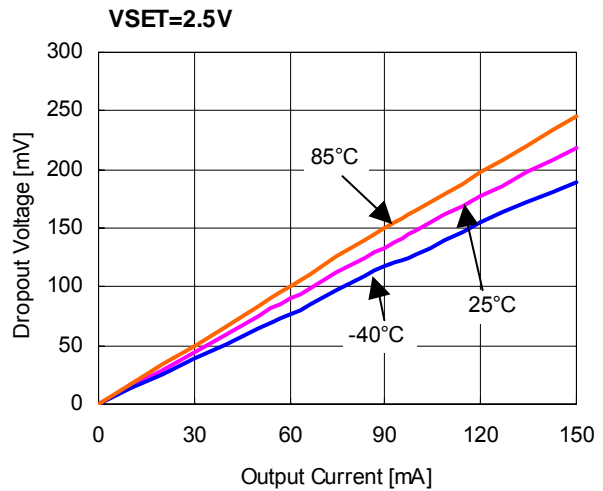
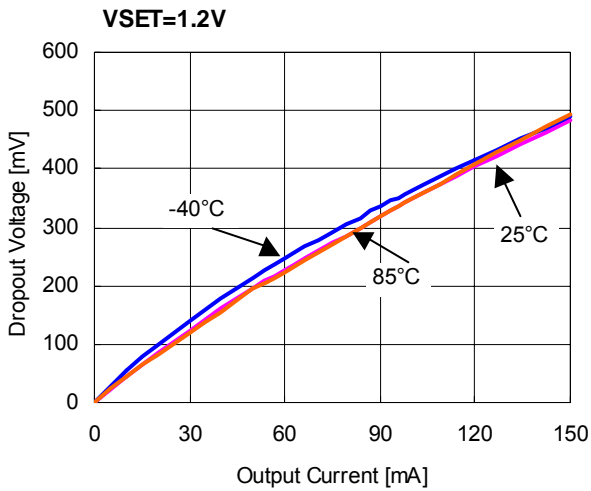

Confidential

7) Dropout Voltage vs. VSET Cin=0.47uF, Cout=0.47uF

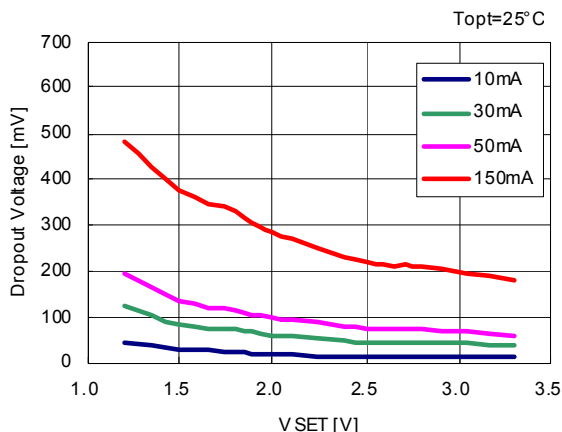

8) Ripple Rejection vs. Input Bias (Cin=none, Cout=0.47uF)

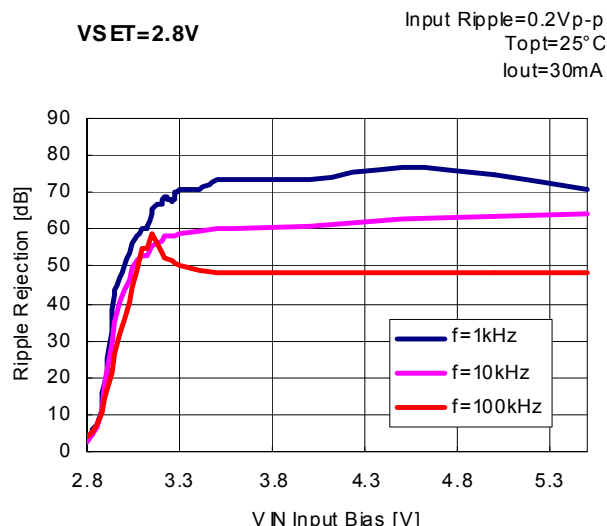
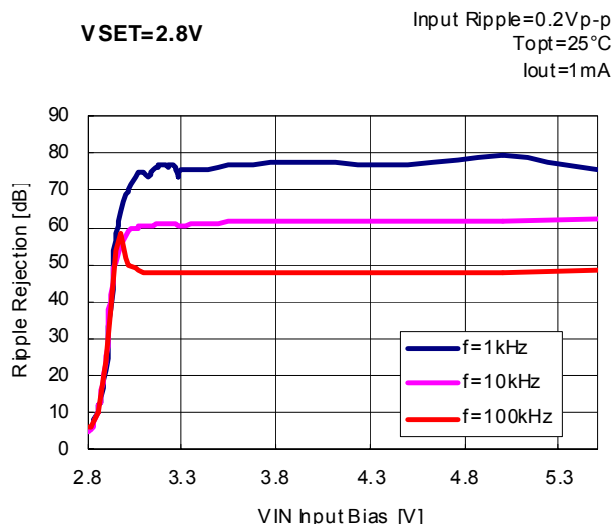

9) Ripple Rejection vs. Frequency Cin=none, Cout=0.47uF

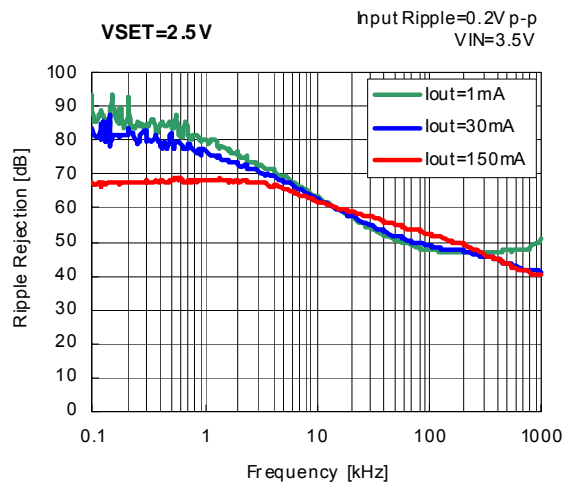
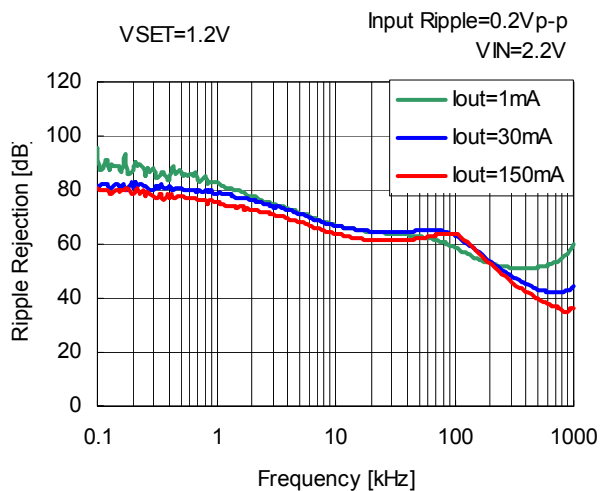

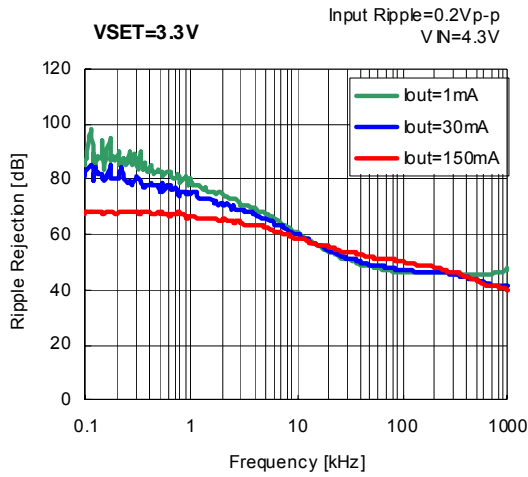

10) Input Transient Response Cin=none, Cout=0.47uF

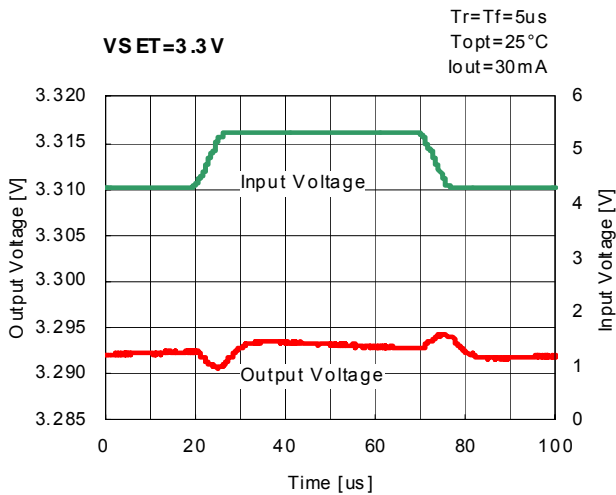
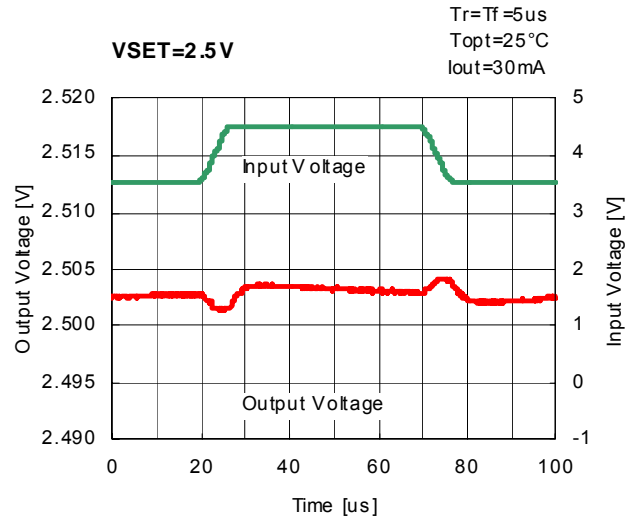
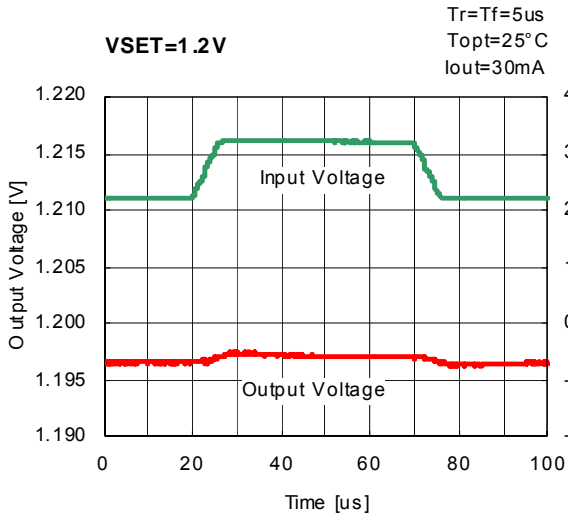

11) Load Transient Response $C_{in}=0.47\mu F$, $C_{out}=0.47\mu F$

VSET=1.2V

VIN=2.2V
Tr=Tf=0.5us
Topt=25°C

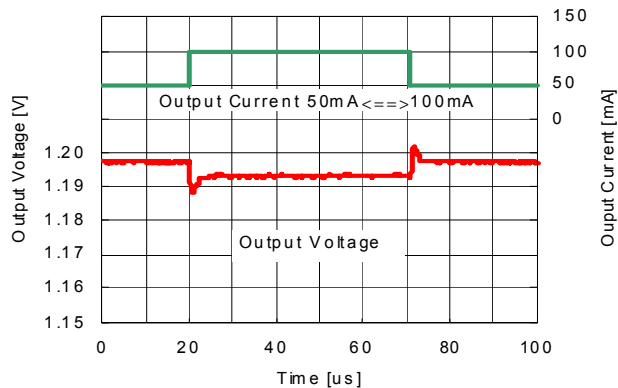

VSET=2.5V

VIN=3.5V
Tr=Tf=0.5us
Topt=25°C

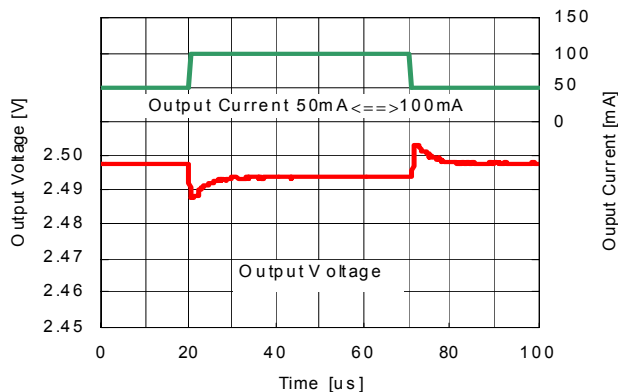

VSET=3.3V

VIN=4.3V
Tr=Tf=0.5us
Topt=25°C

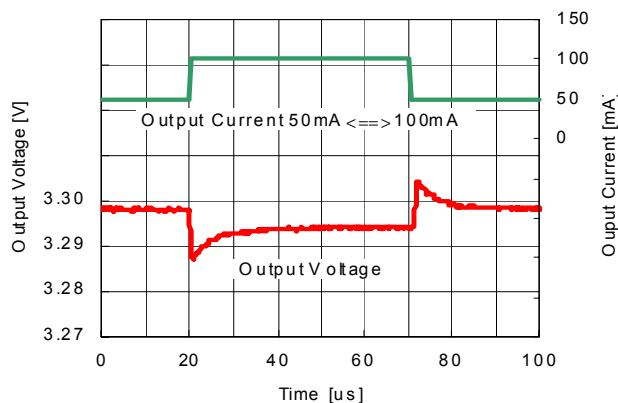

VSET=1.2V

VIN=2.2V
Tr=Tf=0.5us
Topt=25°C

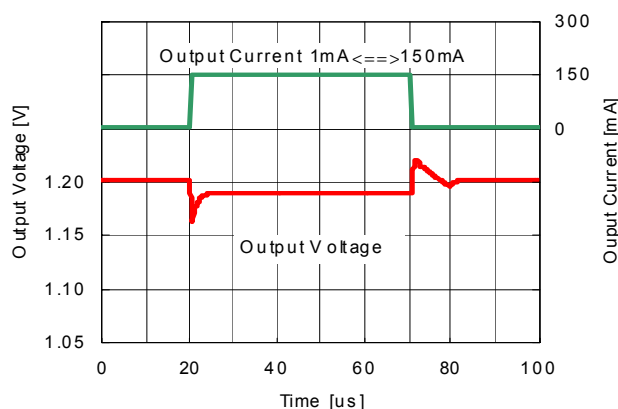

VSET=2.5V

VIN=3.5V
Tr=Tf=0.5us
Topt=25°C

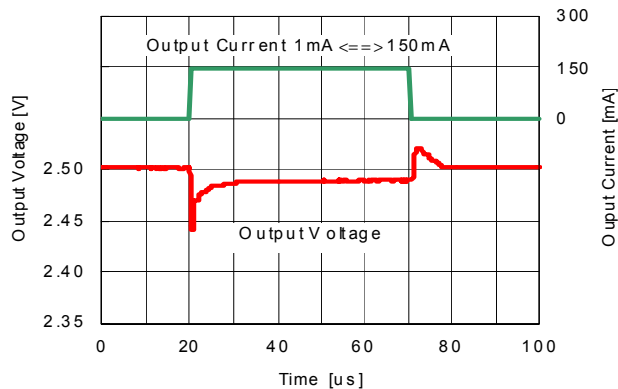

VSET=3.3V

VIN=4.3V
Tr=Tf=0.5us
Topt=25°C

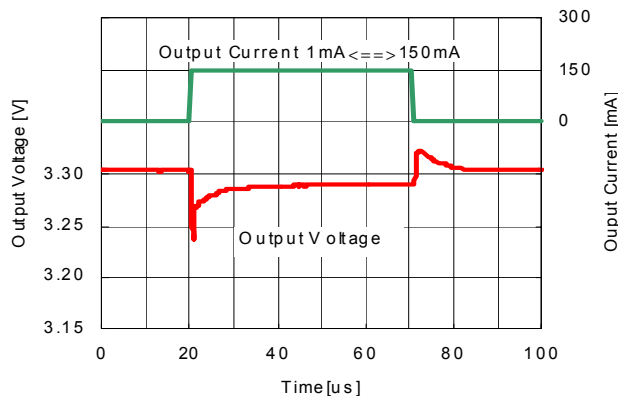

12) Turn On Speed with CE pin $C_{in}=0.47\mu F$, $C_{out}=0.47\mu F$

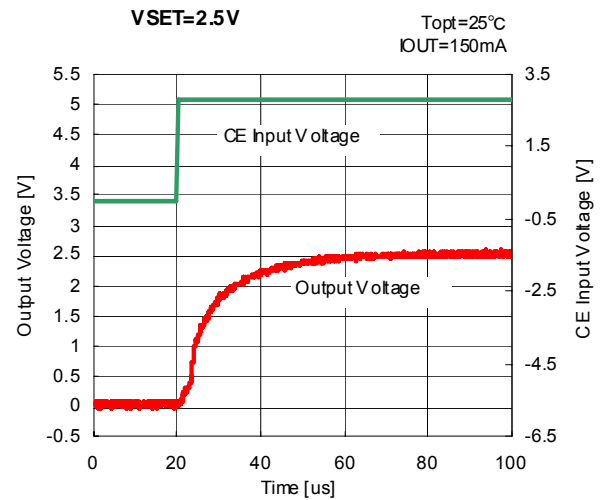
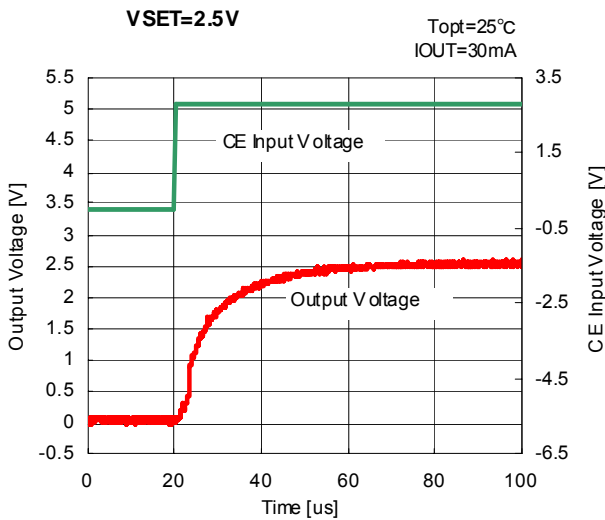
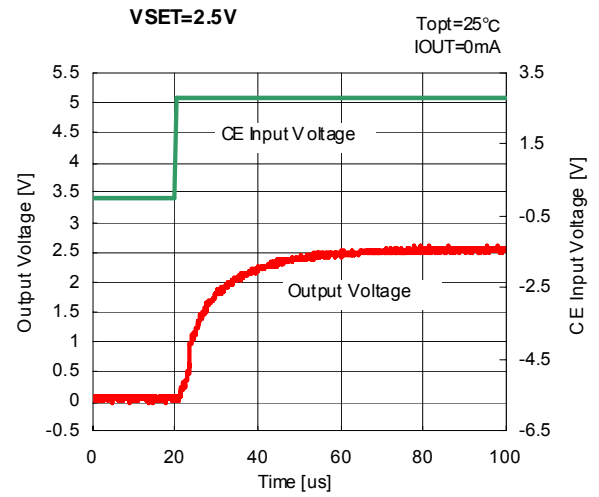
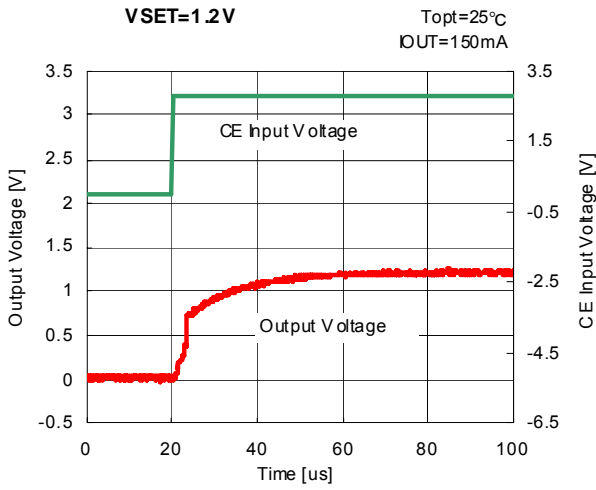
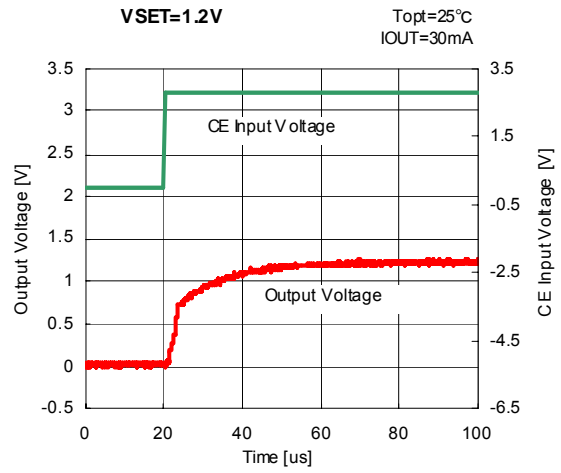
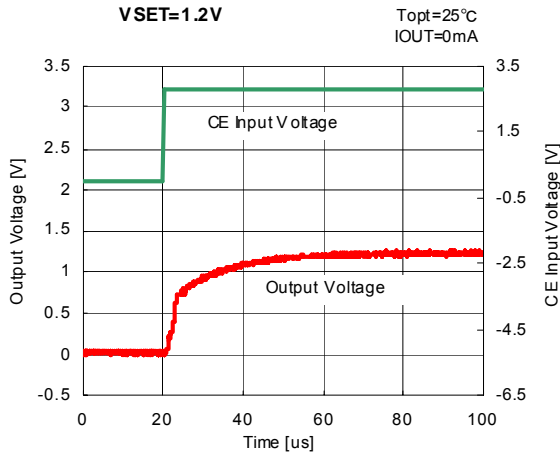

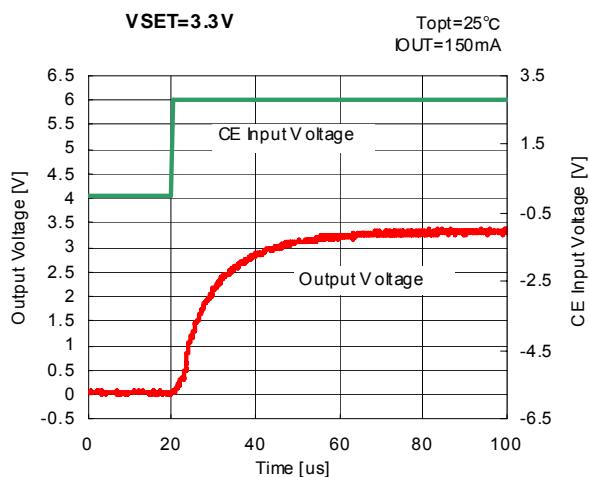
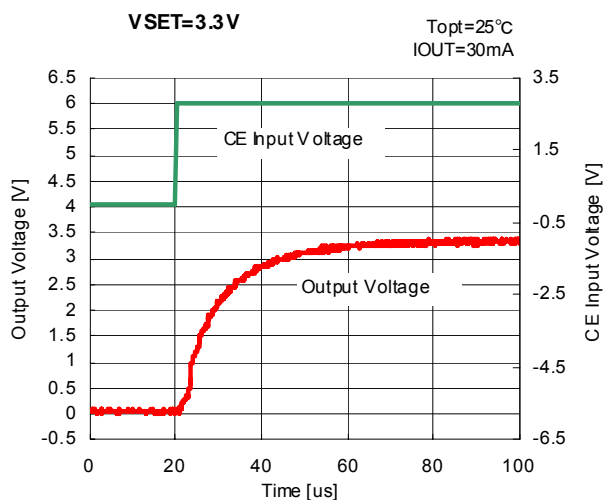
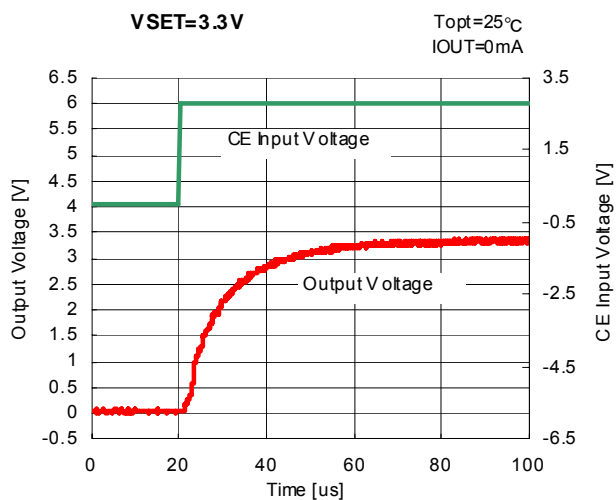

13) Turn Off Speed with CE pin (D Version) C_{in}=1.0uF, C_{out}=1.0uF

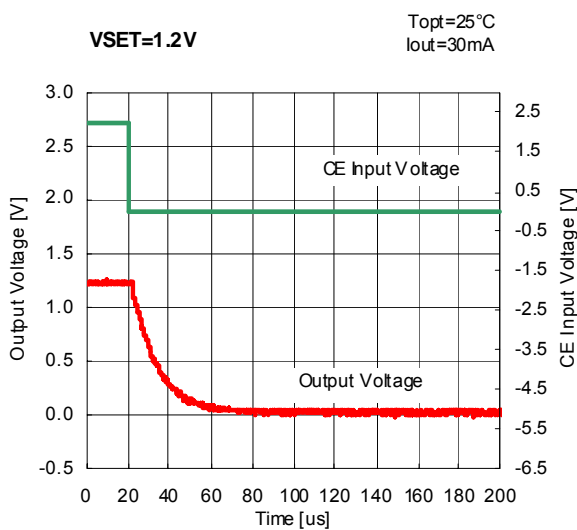
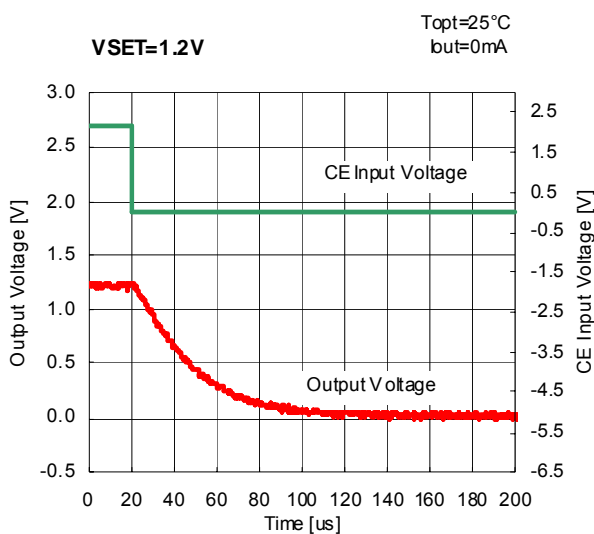

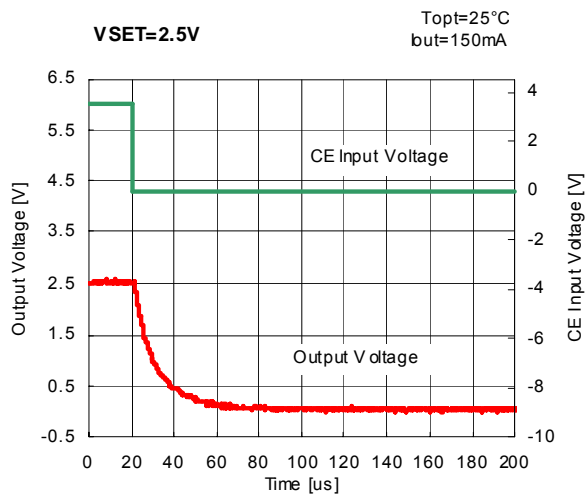
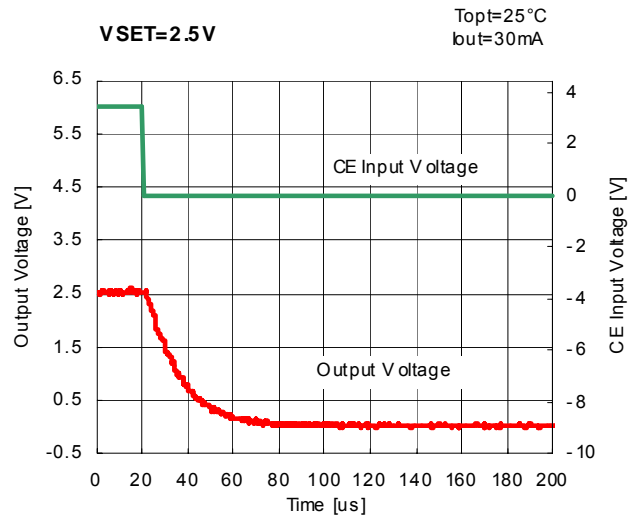
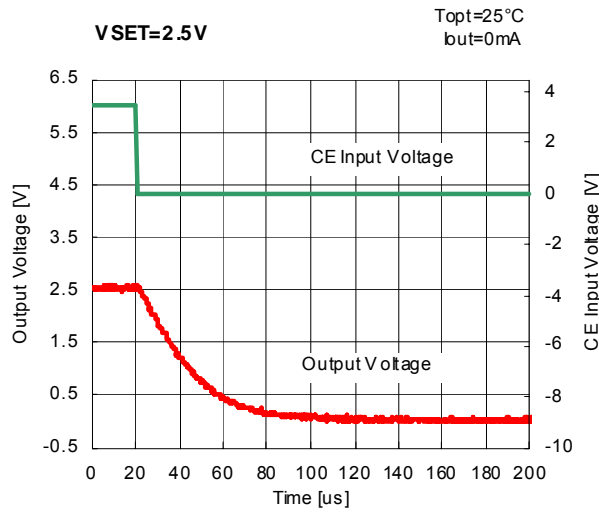
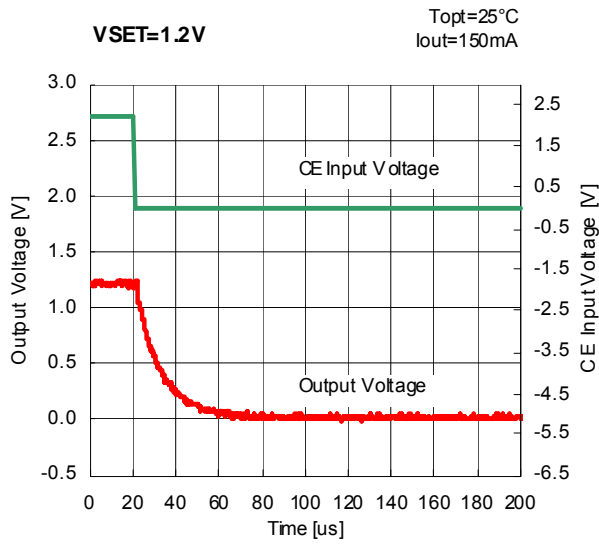

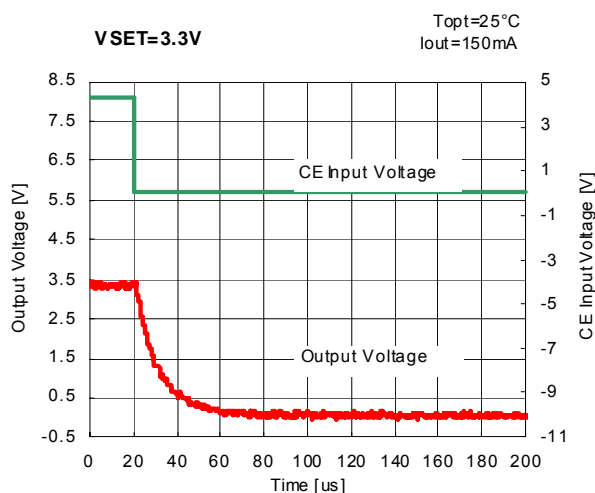
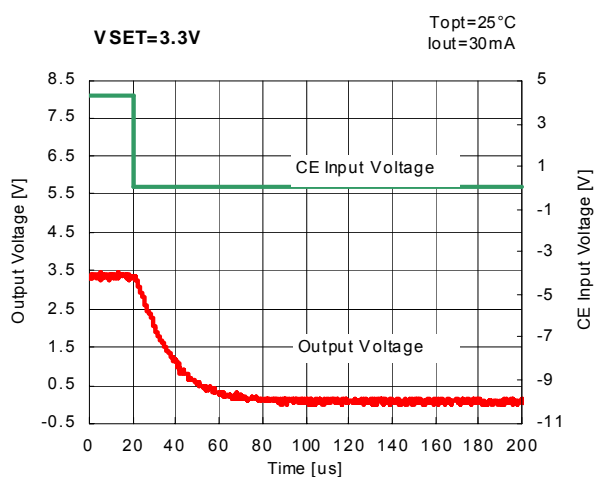
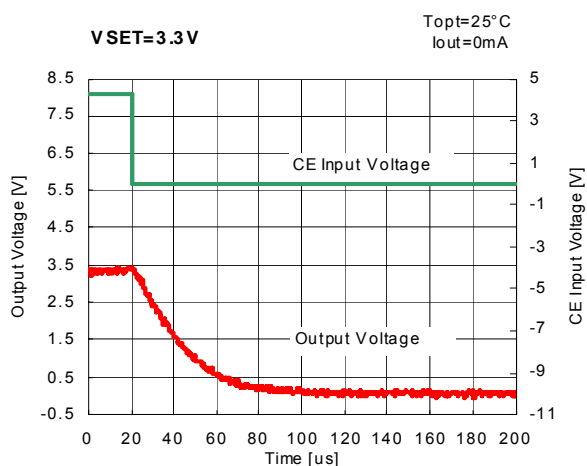

14) ESR vs Output Current (Frequency Band: 10Hz to 2MHz Temperature: -40°C to 85°C)

